

COLORADO

Oak Flooring
1900 mm x 190 mm



COLORADO
Inky Grey [CRD-3002]

COLORADO

FEATURES

Pre-finished matte lacquered planks.

>

Selected Grade, solid oak top wear layer.

>

Three layered construction.

>

Tongue and Groove joining profiles.

>

Fire and Slip Test certified.

www.wonderwoodfloors.com.au



Midnight Grey

CRD-1022
Brushed Lacquer Surface

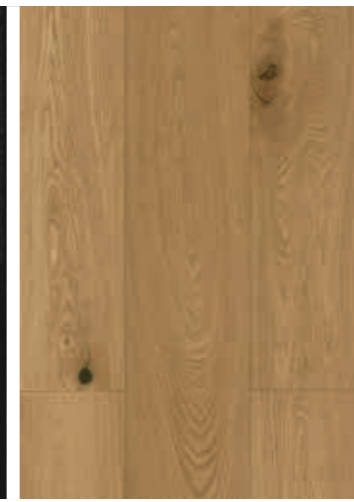

Light Neutral

CRD-3001
Brushed Lacquer Surface



Inky Grey

CRD-3002
Brushed Lacquer Surface

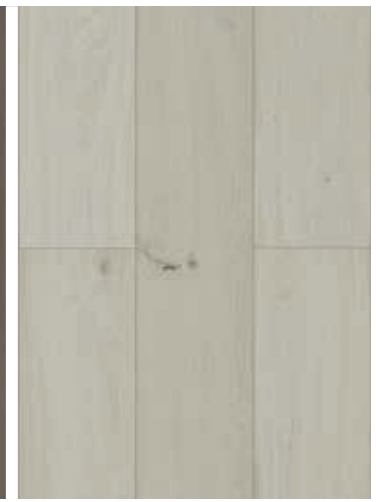

Casper White

CRD-3003
Brushed Lacquer Surface



Brown Leaf

CRD-3004
Brushed Lacquer Surface

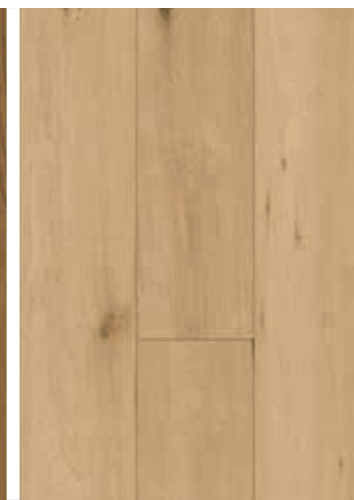

Tinge Clay

CRD-3005
Brushed Lacquer Surface

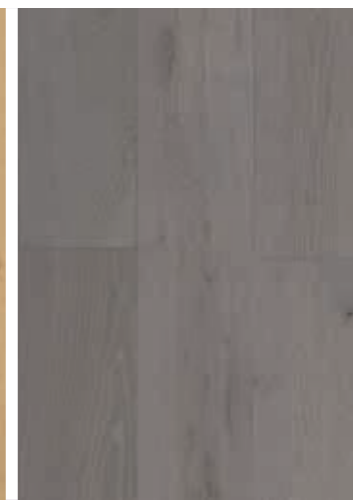

Weathered Grey

CRD-3006
Brushed Lacquer Surface



Lime White

CRD-3007
Brushed Lacquer Surface

TECHNICAL SPECIFICATION

| | | |
|------------------|---------------------------|---------------------------------|
| Timber Grade | ABC | |
| Dimension | Length | 1900 mm |
| | Width | 190 mm |
| | Thickness | 15 mm |
| | Top Layer | 4 mm |
| Bevel | 4-Sided Micro Bevel Edges | |
| Joining System | Tongue and Groove | |
| Supplied | Box Size | 2.888 m ² / 8 Panels |
| | Nesting | < 15% Random Short boards |
| Installation | Direct Stick | Yes |
| | Floating | Yes |
| Moisture Content | 8-12% | |
| Warranty - Wear | Domestic | 25 Years |
| | Commercial | By Request |



WONDERWOOD
www.wonderwoodfloors.com.au



COLORADO
Midnight Grey [CRD-1022]

OAK STAIR NOSE

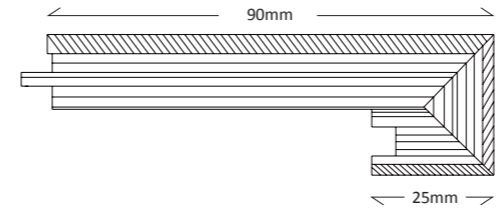

| COLLECTION | OAK ST | COLORADO |
|---------------------|--|-----------|
| Supplied Per Length | 2.2 meter | 1.9 meter |
| Material | Manufactured from pre-finished engineered timber | |
| Features | Square Nose Front | |
| | Available in all colours | |

SKIRTING

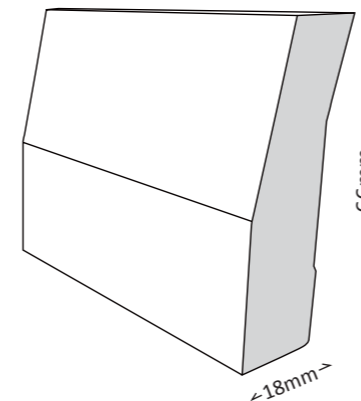
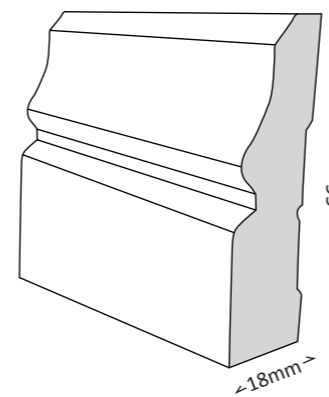
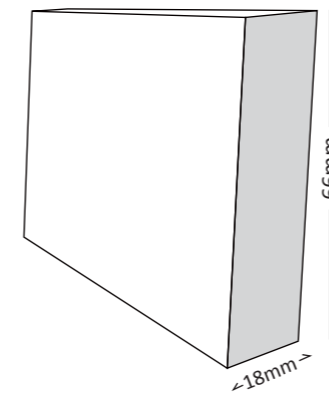

| DAR | | |
|---------------------|------------|-----------|
| Supplied Per Length | Length | 2.7 meter |
| | Width | 66 mm |
| | Thickness | 18 mm |
| Material | Solid Pine | |
| Finish | Undercoat | |

| COLONIAL | | |
|---------------------|------------|-----------|
| Supplied Per Length | Length | 2.7 meter |
| | Width | 66 mm |
| | Thickness | 18 mm |
| Material | Solid Pine | |
| Finish | Undercoat | |

| HALF SPLAY | | |
|---------------------|------------|-----------|
| Supplied Per Length | Length | 2.7 meter |
| | Width | 66 mm |
| | Thickness | 18 mm |
| Material | Solid Pine | |
| Finish | Undercoat | |

VARIATIONS AND FLOORING FACTS

Wonderwood Floors Products are made from natural materials. Individual pieces and batches may vary in colour, texture and naturally occurring features.

Reproduction in printing and photography are for guidance only. These give an indication of colour and are not necessarily representative of the overall effect or design.

When making your selection, please take care when selecting from a single sample, as this is only an indication.

In all jobs, the flooring products supplied will contain variation from board to board and job to job, and from the samples on display. The colour of your flooring may change over time with exposure to UV light.

Each flooring product continues to take up and release moisture during its life, depending on local conditions, environmental conditions and weather changes. Being aware of this and checking conditions is important before installation.

For a lasting floor product, it is essential to install your floating floor in accordance with Wonderwood's guidelines. Please read installation guides before proceeding with your flooring installation.



WONDERWOOD

www.wonderwoodfloors.com.au